

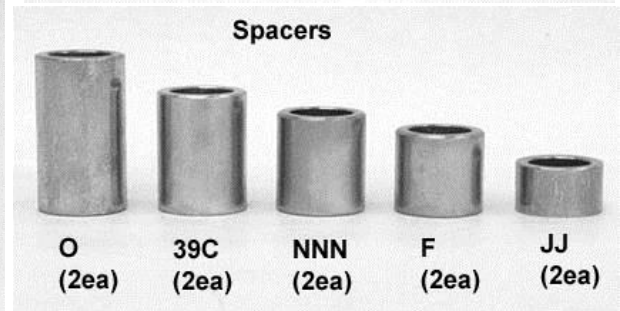

INSTALLATION INSTRUCTIONS

LK-P-RZR-1KS

Parts Diagrams

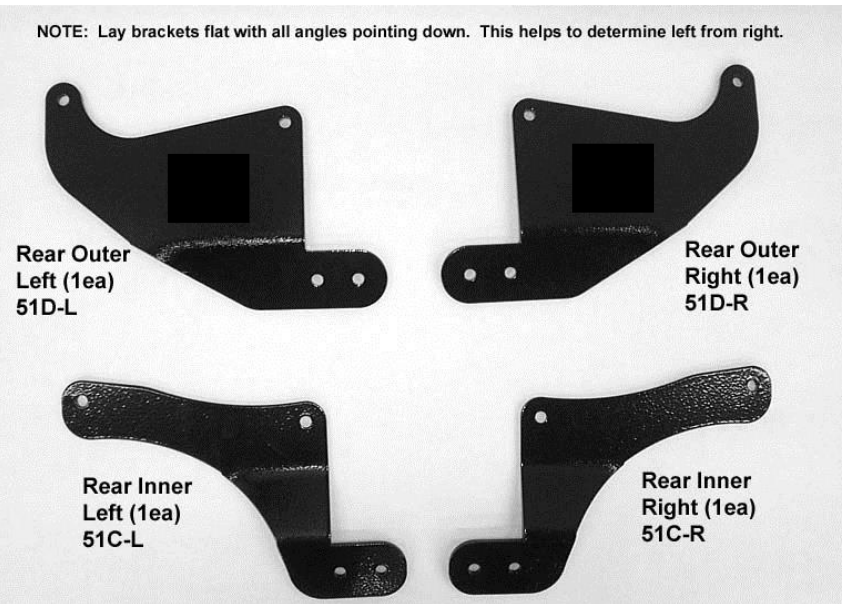
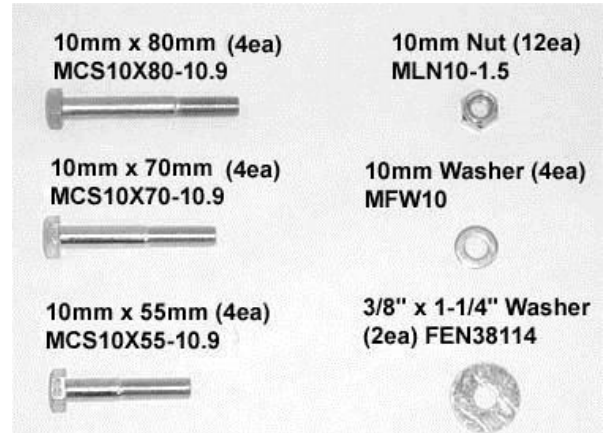
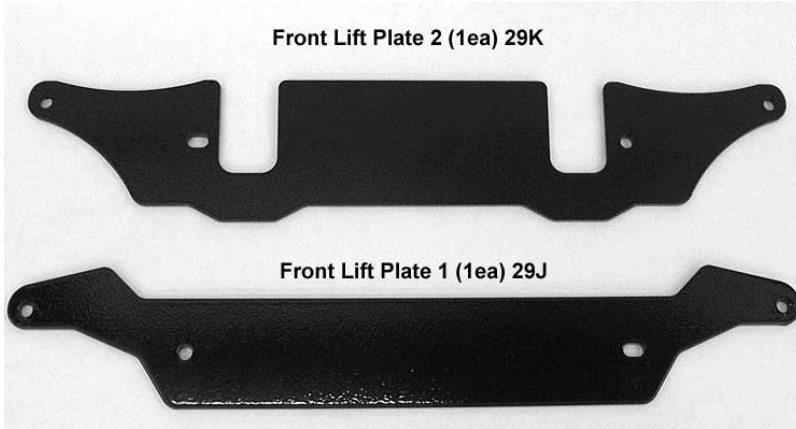

Read instructions and view illustrations before beginning.

Liability Statement

This product is designed for use on ATVs and/or RUVs to increase ground clearance and fender clearance. It is designed for utility type, slow-speed use on relatively flat terrain in deep mud or snow. Purchasers should be aware that use of this product may increase the frequency of required maintenance, part wear, and will raise the center of gravity on your ATV and/or RUV, increasing risk of roll-over, injury and death on all types of terrain. It is your responsibility to always inform other operators and passengers of this vehicle about the added risks.

We recommend that wider tires and/or wheel spacers be used to achieve a wider stance and to improve stability of the ATV and/or RUV. Riders should be advised that the handling characteristics of a taller ATV and/or RUV are different and require extra care when riding, particularly on side hills or off-camber situations. If you further raise the center of gravity by adding taller tires, heavy loads to racks or seats, or by any other means, the ATV and/or RUV must be operated with even more care, at slower speeds and on relatively flat ground. All turns should be done at a slow speed, even on level ground.

If this product is not what you expected, or is not consistent with your intended use, you should return the product immediately to the seller, before installation, for a refund of the purchase price; less any fees. After installation, product is warranted for 90 days for defects in workmanship and materials. Warranty is limited to refund of the purchase price or replacement of the kit, at the seller's option.

Front Lift Installation

1. Place transmission in park. Place jack under center of front end and lift until front wheels clear the ground. Be careful to properly secure and support so that A-arms and shocks can droop to full extension.
2. Remove front wheels.
3. Open the hood and you will need to reroute the headlight wires. Currently they run up from below the cross member on frame and connect to the lights.

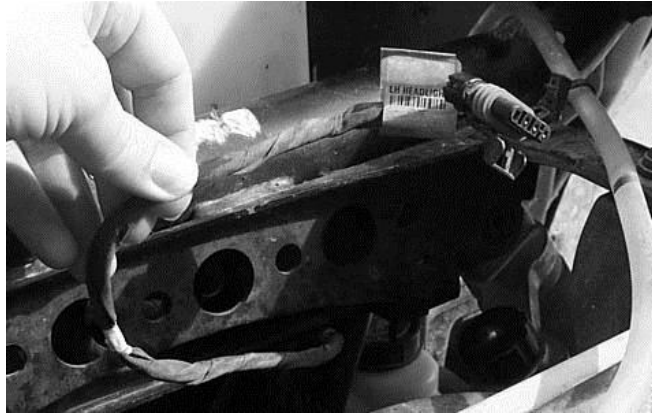

4. Run the wires behind the cross member on the frame and reconnect to the lights.

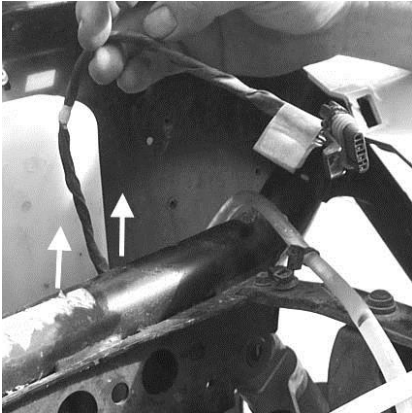

5. Disconnect the top of the front shocks.



6. Next insert the long front lift plate in front of the front cross member. Insert it through the hood opening.

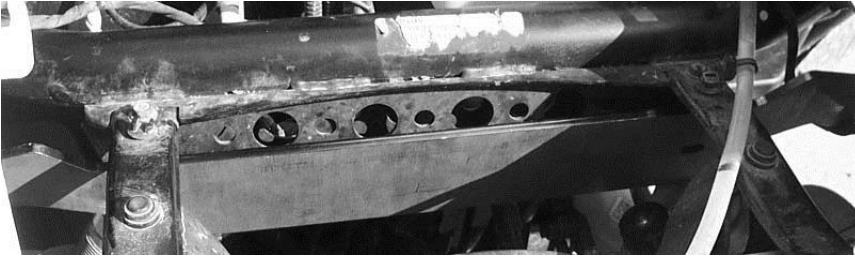
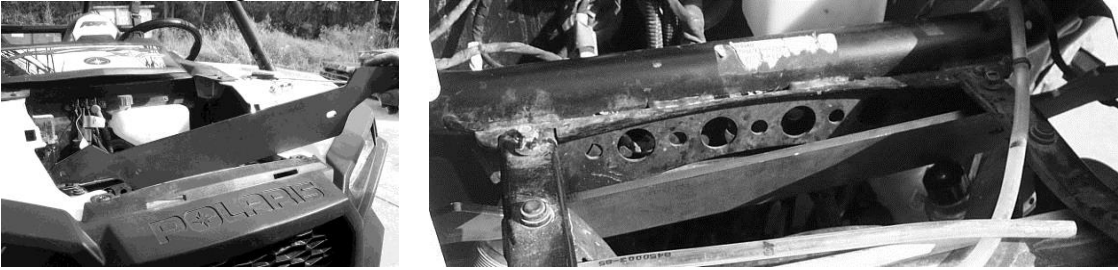

7. Insert the 10 x 70mm bolt through the bracket, placing a 10mm washer between the bracket and the shock mount.



8. Next insert **Spacer O** in the stock shock mount position and push the 10x70mm bolt through. Repeat steps for the opposite side at this time.

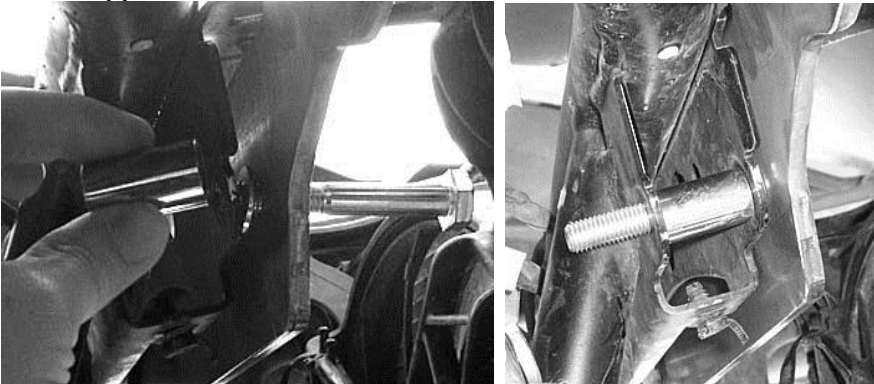

9. Insert the front slotted bracket on the backside of the front cross member.



10. Connect the bracket to the frame by placing it on the bolts and fasten it using the 10mm lock nuts provided.

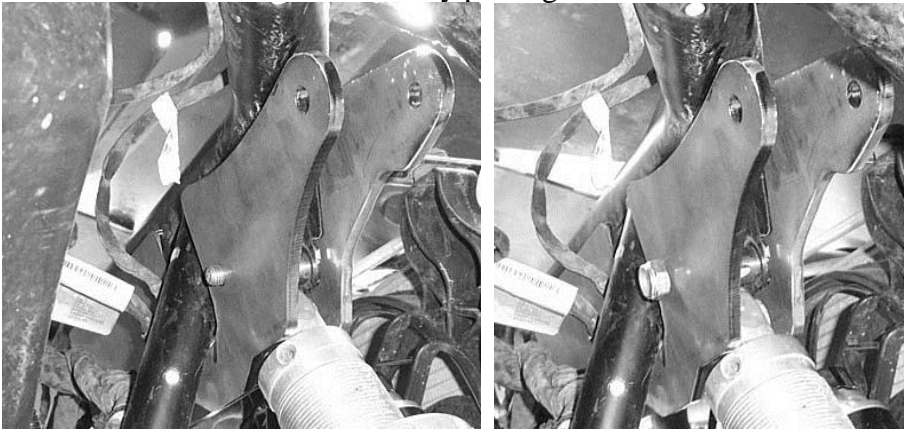

11. Connect the top of the shock to the lift plates. Insert the 10 x 70mm hex bolt through from the backside forward. Place a small **Spacer JJ** between the shock eyelet and the lift plate. Fasten it tight using a 10mm lock nut provided.

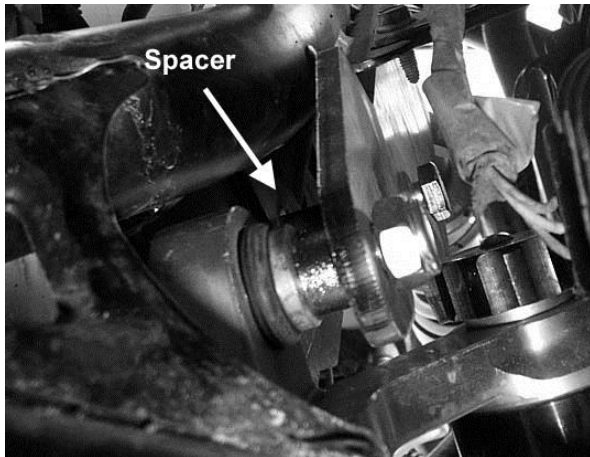
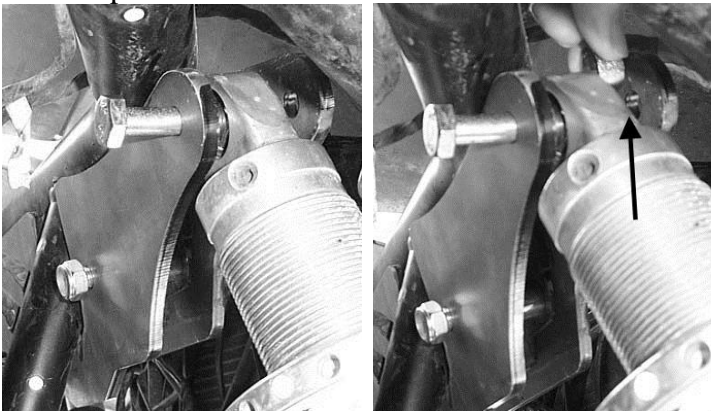

12. Repeat steps for opposite side and tighten all nuts and bolts.

13. Place wheels back on the ATV, torque all lugs to factory specifications.

NOTE: Double check all bolts to verify they are tight. Loose bolts come off and can cause a crash and serious injury or death.

Rear Lift Installation

1. Place UTV transmission in park. Lift the rear of the RZR until the rear trailing arms drop to full extension and tires leave the ground.
2. You will need to remove the rear wheels
3. Disconnect the top of the rear shock from the shock tabs.



4. Starting from the passenger's side, rear right from the seated position; insert the inner right bracket into place **between the shock mount tabs**. But first place a 10x55mm bolt through the lower portion of the bracket. It is going to be very difficult to insert this bolt if you do not install it first. Now insert the bracket into place.



5. Connect the outer rear right bracket to the bolt and secure it loosely with the 10mm nut.

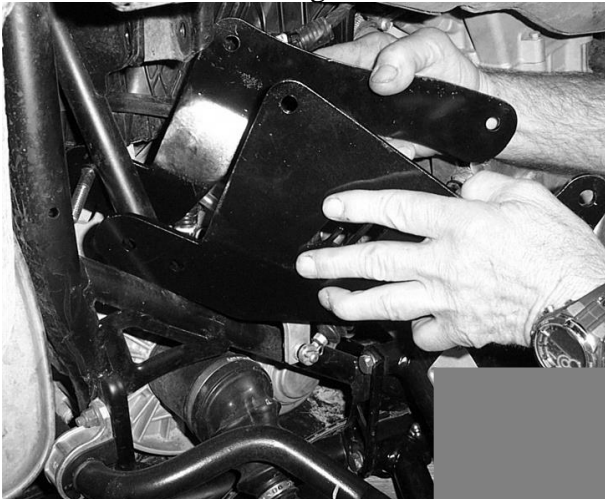

6. Now connect the inner bracket to the frame by inserting the 10x80mm bolt through the frame shock mount tab, then through the bracket. Insert the **Spacer 39C** between the plate and the shock mount tab. Push the bolt through the spacer and tab.

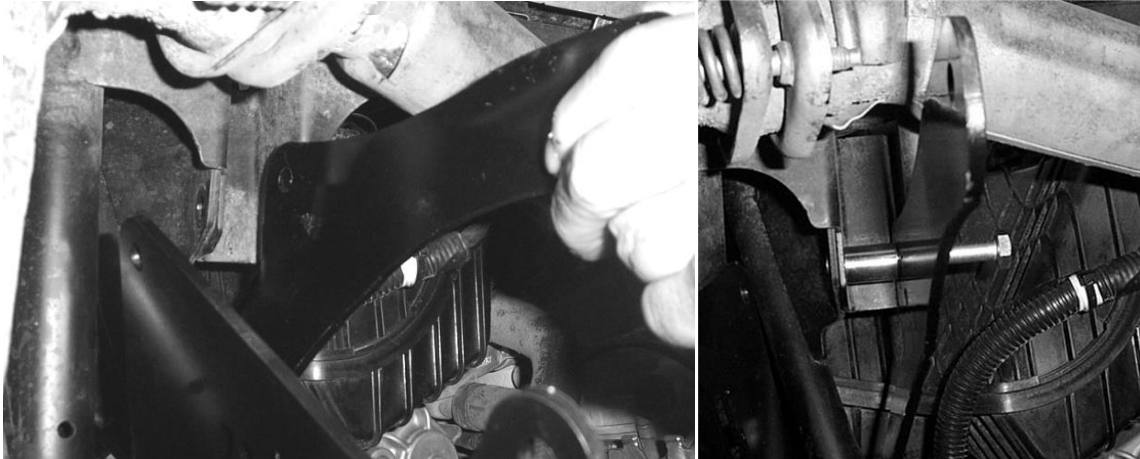

7. Place the **F Spacer** on the outside of the shock mount tab and now place the right outer bracket in place. Loosely connect it using the 10mm lock nut.

NOTE: Make sure that the inner bracket goes in between the shock mount tab, but to the front.

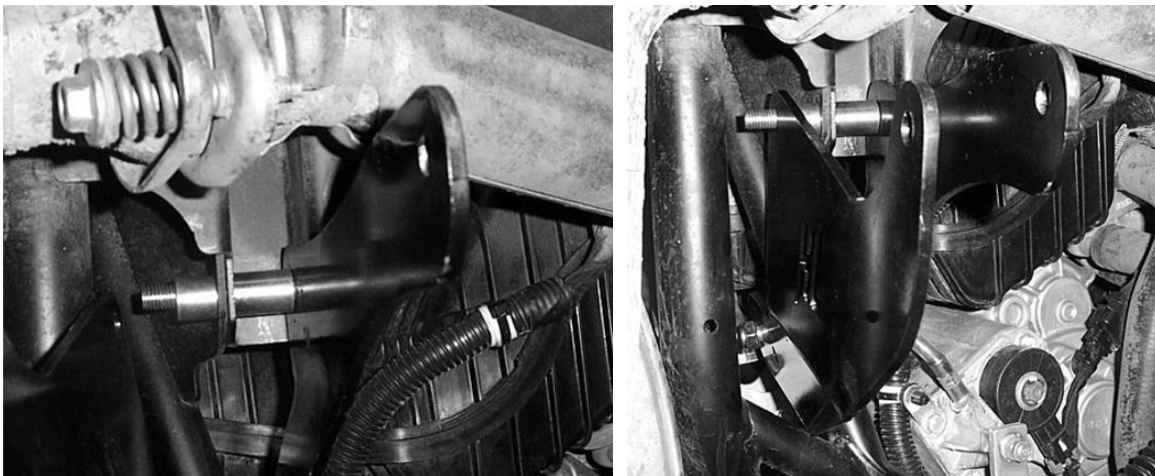

8. Connect the second 10mm x 55mm bolt into the lower portion of the lift bracket and loosely connect the bolts using the 10mm lock nut.

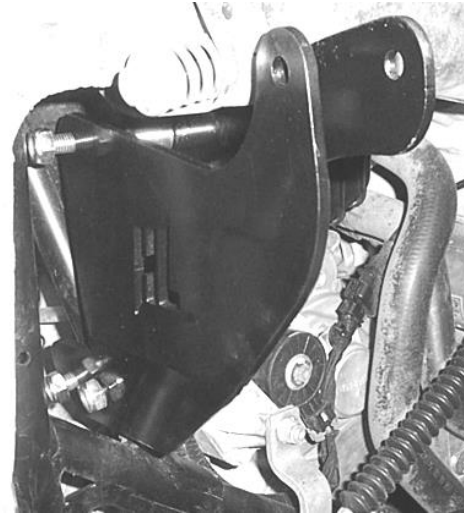

9. Connect the top of the shock to the brackets using the 10x80mm bolt and 5/16" fender washer.

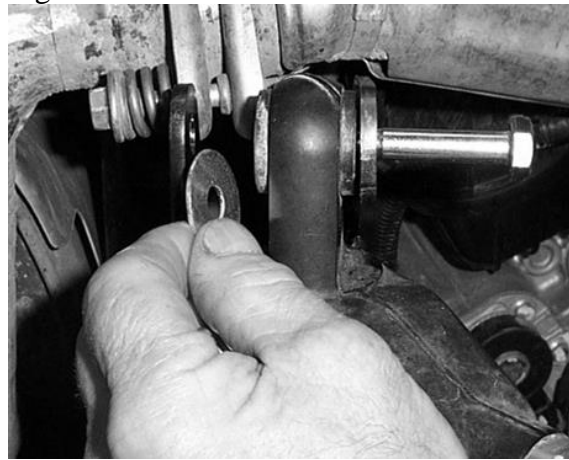
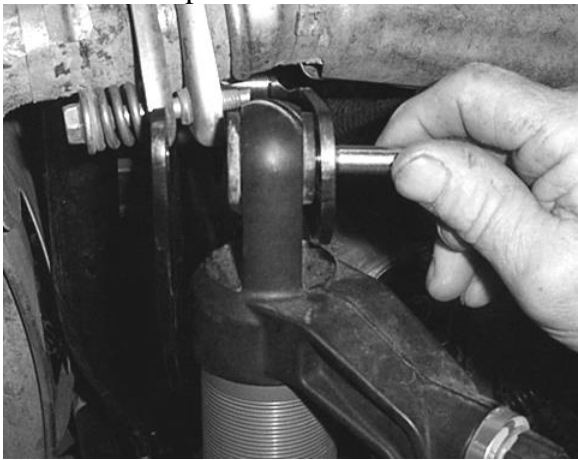

10. Once you have placed the fender washer on the bolt, place the NNN Spacer onto the bolt, and then fasten the bracket to the shock using the 10mm lock nut.

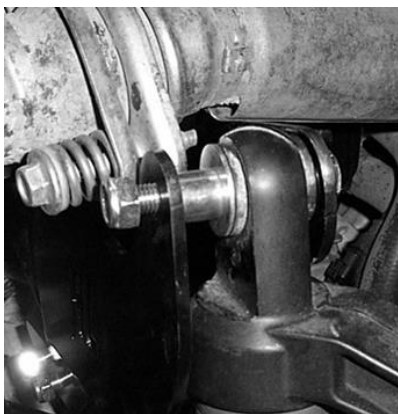
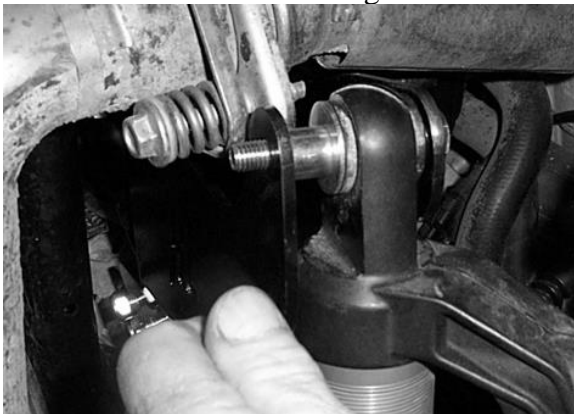

11. Tighten all nuts and bolts.

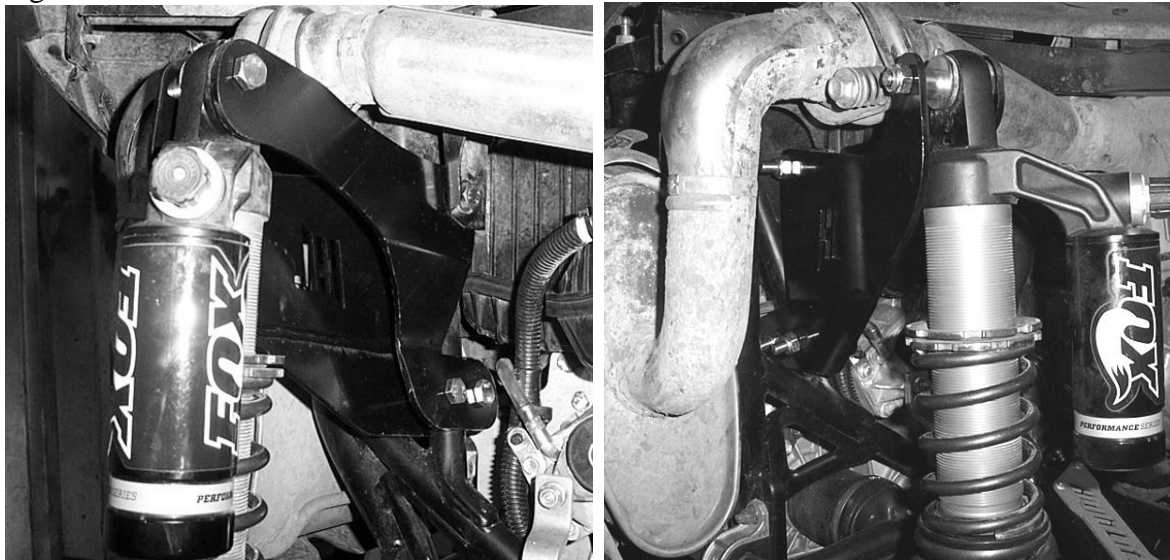

12. Repeat steps for opposite side.

